

PRODUCT DATASHEET

DL SLIM DN 105 6 W 4000 K WT

DOWNLIGHT SLIM ROUND | Flat downlights with integrated driver, round shape

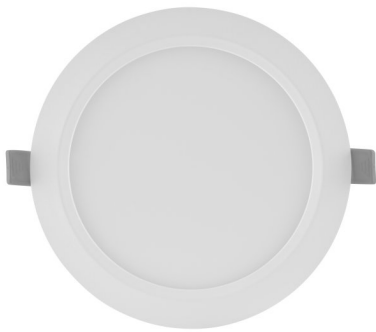

AREAS OF APPLICATION

- Direct replacement for luminaires with compact fluorescent lamps
- General illumination
- Public areas
- Stairways
- Corridors
- Foyers
- Shops

PRODUCT BENEFITS

- Very slim housing
- Low installation depth
- High luminous efficacy
- Energy savings up to 60 % (compared to luminaires that use CFL lamps)
- Very homogenous light
- Functional design
- Easy installation with fast connection
- Simple installation thanks to integrated driver

PRODUCT FEATURES

- Small visible bezel
- Connector box with push wire terminal for tool-free connection
- Light guide made of non-yellowing PMMA for long lifetime



TECHNICAL DATA

Electrical data

Nominal wattage	6.00 W
Operating mode	Integrated LED driver
Nominal voltage	220...240 V
Power factor λ	0.50
Mains frequency	50/60 Hz

Luminaire control gear data

Ouput current	180 mA
ECG - Output ripple current	<6.5 %
Max. no. of lum. on circuit break. B16 A	72
Max. no. of lum. on circuit break. C10 A	60
Max. no. of lum. on circuit break. C16 A	96

Photometrical data

Color temperature	4000 K
Luminous flux	430 lm
Luminous efficacy	70 lm/W
Standard deviation of color matching	<6 sdc _m
Light color (designation)	Cool White
Color rendering index Ra	>80

Light technical data

Beam angle	120 °
------------	-------

Dimensions & weight

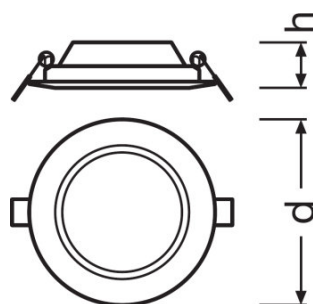

Diameter	118.0 mm
Height	30.0 mm

Product weight	158.00 g
Mounting diameter	105.0 mm

Colors & materials

Body material	Polycarbonate (PC)
Housing color	White
Product color	White
Cover material	Polycarbonate (PC)

Temperatures & operating conditions

Ambient temperature range	-20...+50 °C
----------------------------------	--------------

Lifespan

Lifespan L70/B50 at 25 °C	30000 h
Lifespan L80/B10 at 25 °C	20000 h
Lifespan L90/B10 at 25 °C	12000 h
Number of switching cycles	50000

Additional product data

Mounting type	Recessed
Mounting location	Ceiling / Wall

Capabilities

Dimmable	No
Type of connection	Screwless terminal, 2-Pole
LED module replaceable	Not replaceable

Certificates & standards

Protection class IK (shock resistance)	IK03
Glow Wire Test according to IEC 695-2-1	650 °C
Photobio. safety group acc. to EN62471	RG 0
Protection class	II
Type of protection	IP20
Standards	CE/CB/EAC/RoHS

Light Distribution

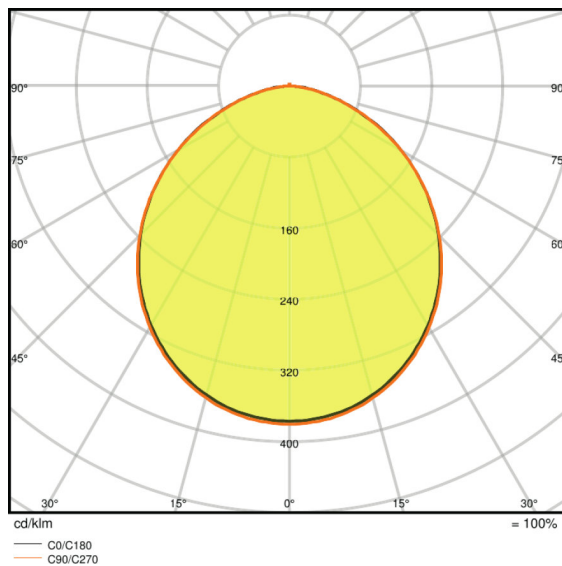
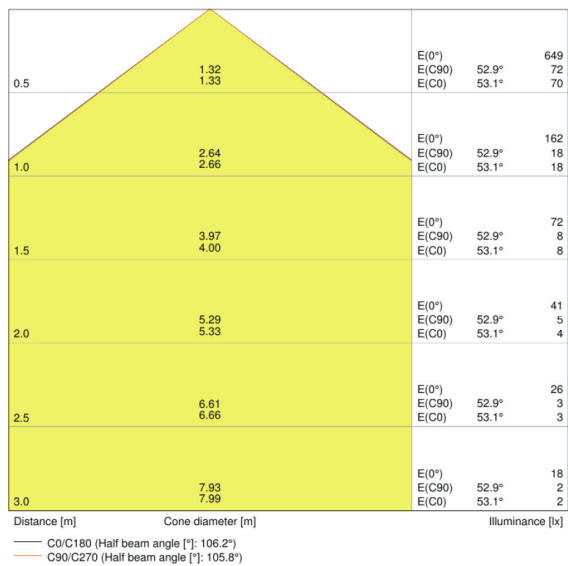

LDC typ cone

LDC typ polar

EQUIPMENT / ACCESSORIES

- Surface mounting frames available as accessories

LOGISTICAL DATA

Product code	Packaging unit (Pieces/Unit)	Dimensions (length x width x height)	Gross weight	Volume
4058075078994	Folding carton box 1	45 mm x 145 mm x 145 mm	192.00 g	0.95 dm ³
4058075079007	Shipping carton box 6	290 mm x 165 mm x 165 mm	1317.00 g	7.90 dm ³

The mentioned product code describes the smallest quantity unit which can be ordered. One shipping unit can contain one or more single products. When placing an order, for the quantity please enter single or multiples of a shipping unit.

REFERENCES / LINKS

For Guarantee see

- ▶ www.ledvance.com/guarantee

DISCLAIMER

Subject to change without notice. Errors and omission excepted. Always make sure to use the most recent release.